

南方安华

NOWFOREVER

E100 Series Inverter

User Manual

V1.3

深圳市南方安华电子科技有限公司

SHENZHEN NOWFOREVER ELECTRONICS TECHNOLOGY CO.,LTD.

Contents

Inspection	1
Sofeware updated description.....	3
1 Summarize	4
1.1 Description of Nameplate.....	4
1.2 Selection guide.....	5
1.3 Technology Criterion.....	6
1.4 Features.....	8
2 Installation	10
2.1 Installation Environment.....	10
2.2 Installation direction and spacell	
2.3 Installation dimensions of inverter	
.....	12
2.4 Installation dimension of keyboard	
.....	14
3 wiring.....	15

3.1	Connection of Periperal devices	15
3.2	Wiring Diagram.....	16
3.2.1	Description of main circuit terminals	16
3.2.2	Jumpers of control circuit	17
3.2.3	Description of Control Circuit Terminals	18
4	Operation	20
4.1	Keypad Description.....	20
4.1.1	Key function description	21
4.1.2	Indicator light description	22
4.2	Operation process.....	23
4.2.1	Fast-monitoring	24
4.2.2	Function codes setting .	25
4.2.3	Information Query	25
4.2.4	Fault Alarm Reset	26
4.2.5	Keyboard digital setting modify	

rapid	26
4.3 Quick debugging.....	27

5 Detailed Function Description.. 28

5.1 P0 Function Group.....	28
5.1.1 Basic Function	28
5.1.2 Simple vector control parameter	34
5.1.3 Input terminals	37
5.1.4 Output terminals	41
5.1.5 Keyboard setting	44
5.1.6 Start and Stop Control .	45
5.1.7 Protect function	46
5.1.8 Multi-step speed	50
5.1.9 PID Control	51
5.1.10 Traverse frequency setting	55
5.1.11 Serial Communication Settings	56

5.1.12 Built-in PLC Run Mode .	57
5.2 P1 Function Groups (Function Codes modify Setting)	64
5.3 P2 Function Groups (reserved)	65
5.4 d0 function groups (read only)	65
6 Fault and trouble shooting.....	66
6.1 Fault and Alarm.....	66
6.1.1 Fault Indication and Fault Reset	66
6.1.2 Alarm Indication and Alarm Reset	67
6.2 Fault and Trouble Shooting....	67
6.3 Common Faults and Solutions...	70
6.3.1 No display after power on:	70
6.3.2 Motor doesn' t move after inverter running	71
7 Maintenance	73
7.1 Inspect the inverter periodically	73

7.2 Replacement of wearing parts.. 74

8 List of Function Parameters.... 75

8.1 P0 function groups(users setup function codes) 75

8.2 P1 function groups(function codes modify setting)..... 90

8.3 d0 Function Groups (fault information of history) 90

8.4 d1 Function Groups (inverter information) 91

8.5 d2 function groups (Inverter running state) 92

8.6 d3 function groups (users interface state) 93

9 MODBUS Communication Protocol.. 95

9.1 MODBUS Communication Modes.... 95

9.2 Information format..... 96

9.3 Examples of MODBUS Information100

9.3.1 To read the contents of storage register	100
9.3.2 Test circuit	101
9.3.3 Write into multi-storage register	102
9.3.4 Data saved instruction	103
9.3.5 Broadcast model sent data	103
9.4 Inverter for slave	104
9.4.1 Instruction Data	104
9.4.2 Monitoring Data	105
9.4.3 Set Data	105
9.4.4 Test Data	105
9.5 Inverter for master	106
9.6 MODBUS Communication Error Codes	107
9.7 Back-check of no response fault for slave	107
Chart Index	109

Inspection

Check the following items when unpacking the inverter,

1. Ensure there is operation manual and warranty card in the packing box.
2. Inspect the nameplate and ensure it is what you ordered.
3. Ensure the optional parts are what you need if have ordered any optional parts.

Please contact the local agent if there is any damage in the inverter or optional parts.

Warranty description

The manufacturer warrants its products from the date of leaving factory. Manufacturer is responsible only for quality problems is caused by product design and production process, it is not responsible for the products were damaged in the course of transportation or discharge box. For the incorrect installation and

use, such as temperature, dust, corrosion and other non-compliance of the working conditions and overload operation, manufacturer is irresponsible.

Software updated description

Firmware version updated for X902, mostly add “interior PLC run mode” relative to X901 version. Please refer to “5.1.12 built-in PLC run mode”.

1 Summarize

Please check the following items when unpacking the inverter, the nameplate and ensure it is what you ordered, the entire exterior of the inverter to ensure there are no scratches or other damage caused by the transportation, ensure there is operation manual and warranty card in the packing box.

Please contact the local agent if there is any damage in the inverter or optional parts.

1.1 Description of Nameplate

MODLE:	A100S1R5B	Model
INPUT:	1PH AC220V 50HZ /60HZ	Input Power
OUTPUT:	8A	rated Output Current
S/N:	Bar Code	
SHENZHEN NOWFOREVER		

Chart 1-1 Nameplate

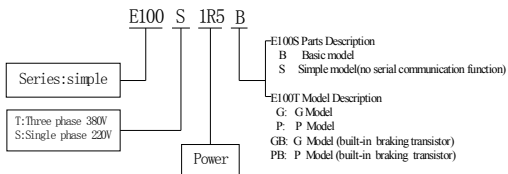

Chart 1-2 Naming rule

remark: may obtain the information of model and power in “dl function groups”.

1.2 Selection guide

Model	Rated output power (KW)	Rated Output Current (A)	Motor Power (KW)
E100S0R4	0.4	3.0	0.4
E100S0R7	0.75	5.0	0.75
E100S1R5	1.5	8.0	1.5
E100S2R2	2.2	10.0	2.2

Chart 1-3 220V series description

Model	Rated output	Rated Output	Motor Power
-------	--------------	--------------	-------------

	power (KW)	Current (A)	(KW)
E100T0R7G	0.75	2.6	0.75
E100T1R5G	1.5	3.8	1.5
E100T2R2G	2.2	5.1	2.2
E100T3R7P	3.7	9.0	3.7
E100T3R7G	3.7	9.0	3.7
E100T5R5P	5.5	13	5.5

Chart 1-4 380V series description

1.3 Technology Criterion

Items		Criterion
Performance	Frequency range	0~600Hz
	Precision of output frequency	0.01Hz
	Distinguish rate of setting frequency	Digital setting: 0.01Hz. Analog setting : AD switch precision for one in thousand, linearity for +/-5%.
	Speed range	1: 100

Items		Criterion
	Overload capability	E100S series: 150%rated current 60s;180%rated current 2s. E100T series(G model): 150%rated current 60s; 180%rated current 2s. E100T series(P model): 120%rated current 60s; 150%rated current 2s. remark: may obtain the informations of model and power in “d1 function groups” .
	Control Mode	Open-loop simple vector control
	Torque boost	Manual torque can be adjust; Auto-Torque upgrade the whole frequency band.
	Start up Torque	when0.5Hz, rated torque for 150%.
Function descriptions	Acc and Dec time	0.1~3200.0s
	Jog function	Jog frequency:0.00~50.00hz;
	Standard functions	Simple vector control、torque boost、automatic slip compensation(rev gain)、stop for DC braking、Restart after power off instantaneous、auto fault reset、control over-current when accelerating speed、multi-step speed 4 run、traverse frequency function applies to textile、closed loop PID control
	Run rule	3kinds control mode: keyboard control, analog terminal control, serial communication control
	Frequency Source Selection	Digital setting, analog voltage setting, analog current setting, the serial communication port setting; can be combined through a variety of ways to switch.
	Input Terminals	4digital input terminals, as many as 13 kinds of custom features, is compatible with the active NPN input; Two analog input terminals, can receive a voltage signal (0 ~ 10V), or current signal (4 ~ 20mA);

Items		Criterion
	Output Terminals	1 relay output, up to 6 kinds of user defined functions; 11 open-collector output, 6 user defined functions; 1 analog output, 4 kinds of user defined functions; can export voltage signal (0 ~ 10V).
	Protection functions	Overvoltage, undervoltage and external fault, overcurrent, overheating, overload
Environment	Installation place	Indoor, Altitude of less than 1 km, clean, non-corrosive gases and no direct sunlight
	Temperature	-10°C ~ +40°C (Inverter will be derated if ambient temperature exceeds 40° C.)
	Humidity	20%~90%RH (without dewfall)
	Vibration	Less than 0.5g
	Storage Temperature	-25°C~+65°C

Chart 1-5 Technology criterion

1.4 Features

1. E100 series inverter uses a simplified vector control technology, with extensive application of functional blocks.
2. Can be the whole frequency band of torque automatic compensation, to compensate for the output torque to meet the user requirements for high torque; to improve the dynamic response and motor control features.

3. Have a proportional, integral and differential (PID) control function of the closed-loop control, can be used for process control ,such as constant pressure water supply.
4. Built-in the function of the textile-specific swing band.
5. Fast current limit (FCL) function, to avoid undue running trip.
6. Built-in DC injection braking.
7. Acceleration / deceleration ramp features have a programmable smoothing function.
8. Prevent the speed lose during over-voltage , in running the inverter automatically limit the increase of DC bus voltage.
9. Fault and fault query monitoring features.
10. Built-in serial communication interface, using standard modbus communication protocol.

2 Installation

2.1 Installation Environment

1. There are vents or ventilation devices in indoor places.
2. Ambient temperature $-10\text{ }^{\circ}\text{C} \sim 40\text{ }^{\circ}\text{C}$. If the ambient temperature is bigger than $40\text{ }^{\circ}\text{C}$, but lower than $50\text{ }^{\circ}\text{C}$, may take off the cover board of inverter or open the front door cabinet, in order to reduce temperature.
3. Try to avoid high temperature and wet places, humidity less than 90%, and without dewfall.
4. Avoid direct sunlight.
5. Away from air pollution such as flammable and corrosive gases, liquids.
6. No dust, floating particles of fiber and metal.
7. It is not allowed that the inverter falls down or suffers from fierce impact or the inverter installed at the place that vibration frequently.

8. Keep away from the electromagnetic radiation source.

2.2 Installation direction and space

In order not to affect the life of converter and reduce its performance, it should be noted mounting direction and the surrounding space, and be properly fixed.

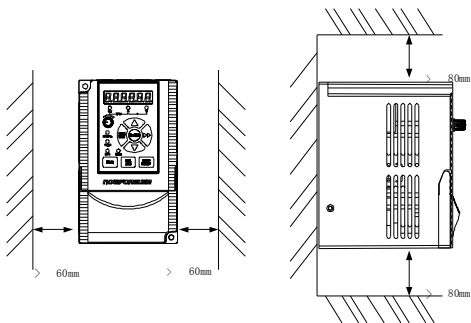

Chart 2-1 Safe space

2.3 Installation dimensions of inverter

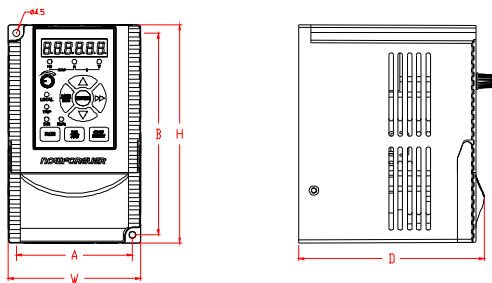

Chart 2-2 External dimension

Installation

Model	A (mm)	W (mm)	B (mm)	H (mm)	D (mm)	Installation Hole (mm)	Net Weight (Kg)
E100S0R4 E100S0R7 E100S1R5 E100S2R2	75	86	131	142	121	φ4.5	1
E100T0R4G E100T0R7G E100T1R5G E100T2R2G E100T3R7P	75	86	131	142	121	φ4.5	1
E100T3R7G E100T5R5P	120	135	175	190	130	φ5.5	2.8

Chart 2-3 list of External Dimension

2.4 Installation dimension of keyboard

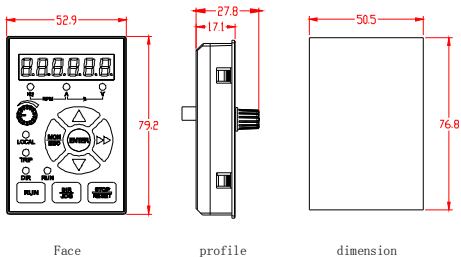

Chart 2-4 installation dimension of keyboard (mm)

3 wiring

3.1 Connection of Periperal devices

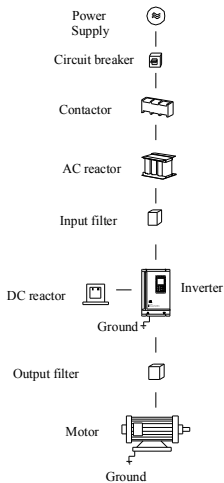

Chart 3-1 connection of periperal devices

3.2 Wiring Diagram

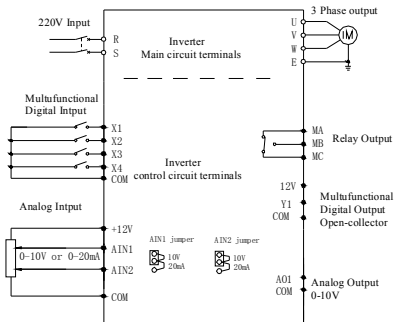

Chart 3-2 standard wiring diagram

3.2.1 Description of main circuit terminals

Terminal Symbol	Function Description
R, S	Terminals of 2 phase AC input (E100S series)
R, S, T	Terminals of 3 phase AC input (E100T series)
U, V, W	Terminals of 3 phase AC output (connect to motor)

Chart 3-3 Description of main circuit symbol

3. 2. 2 Jumpers of control circuit

Name	Function
AIN1 jumper	10V: input signal of AIN1 for 0~10V; 20mA: input signal of AIN1 for 4~20mA.
AIN2 jumper	10V: input signal of AIN2 for 0~10V; 20mA: input signal of AIN2 for 4~20mA.

Chart 3-4 Jumpers of control circuit

3. 2. 3 Description of Control Circuit Terminals

Control panel interface, including digital input and output signals, analog input and output signals.

Items		Terminal s	Name	Function	Specifications
Input	Digital	X1	Multifunctional Input<X1>	Factory settings:forward run	Optical Coupling Insulation. When X terminal and the COM shorted, means that the input terminal is effective.
		X2	Multifunctional Input <X2>	Factory settings:reverse run	
		X3	Multifunctional Input <X3>	Factory settings:Forward jog	
		X4	Multifunctional Input <X4>	Factory settings:reverse jog	
		COM	Digital Input Common	0V	
	Analog	AIN1	Analog setting 1	Can be used frequency setting; PID feedback、PID setting.	DC:0 ~ 10V or 4~20mA; selection by jumper.
		AIN2	Analog setting 2		
		COM	Analog input common		
output	Relay	MA	A node output	MA—MC:NC	Node

Items		Terminal s	Name	Function	Specifications
		MB	B node output	node MB—MC:NO node	Capacity: AC250V, less than 2A; DC30V, less than 1A.
		MC	node output common		
	Digital	Y1	Optical Coupling output1	Factory setting: inverter is running	Open-collector output Optical Coupling Output Capacity: DC36V, less than 50mA.
		COM	Optical Coupling output common	0V	
	Analog	AO1	Analog output1	factory setting: output frequency	Output Capacity: voltage: 0~ 10V, less than 2mA;
		COM	Analog output common		
Power	12V	DC12V:power positive	Can be used as analog input power、 Digital output power.	Output capacity:les s than20mA;	
	COM	DC12V:power negative			
Communication	+485	RS485 +	MODBUS	MODBUS protocol Max38.4kBP S	
	-485	RS485 -			

Chart 3-5 Description of control circuit terminals

4 Operation

4.1 Keypad Description

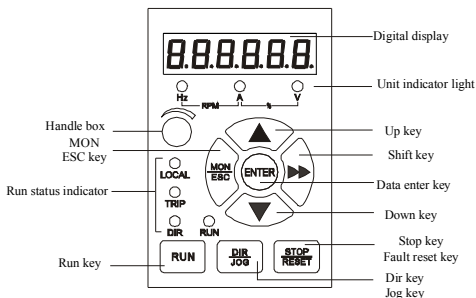

Chart 4-1 Keypad schematic diagram

4. 1. 1 Key function description

Button symbol	Name	Function
MON/ ESC	Monitor/ Escape key	1.Switch to system minitor state. 2.Escape to first-level menu. 3.In alarm state,clear away alarm.
ENTER	Data/ Enter key	1.Enter menu. 2.Confirm modified data.
>>	Shift key	1.In fast monitor state, switch the monitor parameters. 2. when modifying the data, switch to the modify position. 3. Modify function code, press 10 to increase. (Only valid P0 functional group)
▲	UP key	increase data or function codes
DIR/ JOG	JOG key	According to this function code can achieve a function: 1. Switch between forward and reverse. 2. Start-up the inverter in JOG state, relax the key result in stopping JOG.
RUN	Run key	Start to run the inverter in keypad control mode.
▼	DOWN key	Decrease function codes or data.
STOP/ RESET	Stop / Reset key	1. In running status,stop the inverter. 2. When fault alarm, can be used to reset the inverter without any restriction. 3. Emergency stop function can be realized. (Equivalent to the external fault input)

Chart 4-2 Key function description

4. 1. 2 Indicator light description

4. 1. 2. 1 Run state indication

Indicator Light Name	Indicator Light State	State Description
RUN	Light on	Operating or JOG status
	Flickering	The inverter is decreasing speed until stop.
	Extinguished	stop status
DIR	Light on	Reverse state
	Flickering	Switching to forward and reverse.
	Extinguished	Forward state
LOCAL	Light on	Operation panel control state (local control)
	Extinguished	Terminals or communication control state.
TRIP	Light on	Not serious fault alarm (over current, over voltage)
	Extinguished	The inverter output current and generator voltage are normal

Chart 4-3 Run state indicator light description

4. 1. 2. 2 Unit indication

In fast monitor state, indicate monitor unit and data.

Data order	Indication	Range	Unit
Setting frequency	light on	0.00~600.00Hz	0.01Hz
Output frequency	flickering	0.00~600.00Hz	0.01Hz
Output current	light on	0.1~2000.0A	0.1A
Output voltage	light on	0.1~2000.0V	0.1V
DC bus voltage	flickering	100~1000V	1V

Chart 4-4 unit indicator light description

4. 2 Operation process

Four levels of menu as below:

Operation state	Main contents
Fast monitor	Fast monitor 5 kinds of run states. Including setting frequency, output frequency ,output current and so on.
Function code setting	Modify function code, the P function group of first-level menu.
Information query	Inquire about information and run state .the d function group of first-level menu.
Fault Alarm Reset	The inverter fault alarm display and reset.
Quick modify keyboard digital setting	When the frequency setting source is the keyboard digital setting, modify the setting frequency rapidly. (UP, DOWN function)

Chart 4-5 Description of the inverter operation status

4. 2. 1 Fast-monitoring

After power-on initialization, the inverter automatically switches to the fast monitor status. If want to enter the fast-monitoring status in other states, you can press "monitor key" to enter. In the fast-monitoring state, use the "shift key" to switch monitor parameters. A total of 5 operational status can be monitored, the monitor status order and the dicator light reference Chart 4-6.

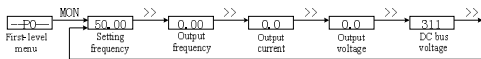

chart 4-6 Fast-monitoring diagram

4.2.2 Function codes setting

The function codes of P0、P1 function group in first-level menu are can read-write parameters, users can modify.

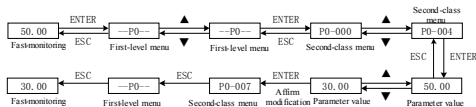

Chart 4-7 Function code setting diagram

4.2.3 Information Query

The function codes of d0、d1、d2、d3 function dc group in first-level menu for read only parameters, users can only look over.

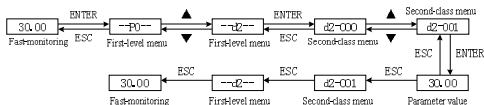

Chart 4-8 Information query diagram

4. 2. 4 Fault Alarm Reset

If the inverter has fault or alarm, it will prompt the related fault information. Codes for the E001 to E030.

If the inverter has E001 to E029 fault, please use the "reset button" to clear the fault.

If the inverter has a E030 alarm, please use the "ESC button" to clear the alarm.

4. 2. 5 Keyboard digital setting modify rapid

When P0-002 = 0, P0-003 = 1, the frequency source for the keypad digital setting.

When inverter in a parking state, UP, DOWN monitor a given frequency in effect in the fast-monitoring mode;

Inverter in running, UP, DOWN in effect in the fast-monitoring mode.

4.3 Quick debugging

Set the basic function code in operation ,refer to the following diagram .

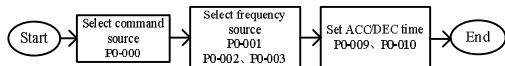

Chart 4-9 Quick debugging flowchart

5 Detailed Function Description

This chapter introduces the function codes setting of the P0, P1, P2 function group. d0, d1, d2, d3 function group for running information query of the inverter, reference "8 Function Code List" .

5.1 P0 Function Group

5.1.1 Basic Function

P0-000	Select command source	Setting range: 0~2	Factory value: 0
--------	--------------------------	--------------------	------------------

Command source is that a channel ,the inverter receives some instructions (run、 stop、 jog、 running direction,and so on).

0: keyboard control.

1:Analog terminal control

2:communication control

Detailed Function Description

P0-001	Select frequency source	Setting range:0~4	Factory value: 0
--------	-------------------------	-------------------	------------------

0:Main frequency source x.

1:Assisiant frequency source Y.

2:Main frequency source x + Assistant frequency source y.

3:max (Main frequency source x, Assisiant frequency source y) .

4:Switch by selection terminals of frequency source.

P0-002	Main frequency source x selection	Setting range: 0~7	Factory value: 0
P0-003	Assistant frequency source Yselection	Setting range: 0~7	Factory value: 0

0: Keyboard potentiometers. Adjustable range between the lower limit frequency and upper limit frequency.

1: Keyboard digital settings (UP, DOWN). When inverter in a parking state, it is effective to monitor setting frequency in the

fast-monitoring mode with UP, DOWN key ; When inverter is running, it is effective in the fast-monitoring mode with UP, DOWN key.

2:AIN1. Setting frequency is controlled by the input analog terminal AIN1 .

3:AIN2. Setting frequency is controlled by the input analog terminal AIN2.

4:Multi-segment speed. Setting frequency is controlled by the multi-function input terminals .

5:PID closed loop running. Setting frequency is set by PID operation.

6:serial communication setting. Setting frequency is set by the serial communication .reference the description of serial communication.

7: interior PLC run mode.

P0-004	Keyboard digital	Setting range :	Factory value:
--------	------------------	-----------------	----------------

Detailed Function Description

	setting frequency	0.00~600.00Hz	50.00Hz
--	-------------------	---------------	---------

Set the keyboard digital setting frequency value .

P0-005	JOG frequency	Setting range : 0.00 ~ 600.00Hz	Factory value : 5.00Hz
--------	------------------	------------------------------------	---------------------------

After inverter has received JOG command, will run in the setting frequency of the function code.

P0-006	Running direction control	Setting range: 0~ 2	Factory value: 0
--------	------------------------------	------------------------	------------------

0: It is same with setting direction. Run according to the instruction direction .

1: It is opposite with the setting direction. Run according to the instruction opposite direction . the function can change the direction of motor rotation ,but don' t change the wiring between the inverter and the motor .

2: reverse prohibited. reverse run is prohibited.

P0-007	Upper limit frequency	Setting range: 0.00~ 600.00Hz	Factory value : 50.00Hz
P0-008	Lower limit frequency	Setting range: 0.00~ 600.00Hz	Factory value : 0.00Hz

Set the maximum and minimum value of output frequency.

Notice :set the upper and lower limit frequency mostly prevent personnels mistake operation.inverter will avoid the motor overheat caused by low frequency , or because of the high frequency caused by mechanical wear and so on.

P0-009	Accelerate speed time	Setting range: 0.1~ 3200.0s	Factory value : 15.0s
P0-010	Decelerate speed time	Setting range: 0.1~ 3200.0s	Factory value : 15.0s

This function code of 15.0s the meaning for the accelerate time(0

Hz ~50 Hz) or deceleration time(50 Hz~0 Hz).

Notice: The factory value is different according to inverter power.

P0-011	Carrier frequency	Setting range : 1.0 ~ 10.0KHZ	Factory value : 6.0KHZ
--------	-------------------	-------------------------------	------------------------

Set the PWM output carrier frequency. Carrier frequency have effect for the motor noise、inverter thermal and environment interference、temperature rise of motor and inverter.

Carrier frequency	Electromagnetism noise	Cacophony/leak current	Inverter temperature rise	Motor temperature rise	Motor noise	Output Current wave
2KHZ	small	small	small	big	big	poor
5KHZ						
10KHZ	big	big	big	small	small	Good

Chart 5-1 Setting reference of carrier frequency

5. 1. 2 Simple vector control parameter

P0-012	V/F curve setting	Setting range: 1~7	Factory value: 1
--------	-------------------	--------------------	------------------

1:50 Hz motor, the general load;

2:50 Hz motor, high starting torque;

3:50 Hz motor, reduced torque

4:60 Hz motor, the general load;

5:60 Hz motor, high starting torque;

6:60 Hz motor, reduced torque

7: factory test.

Detailed Function Description

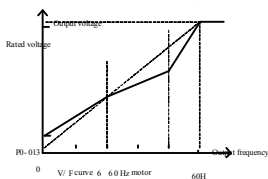
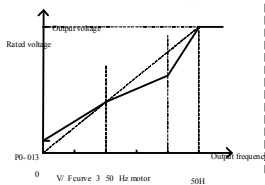
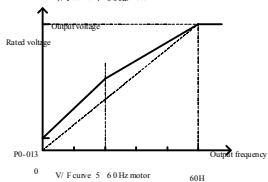
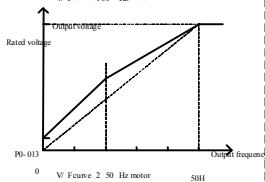
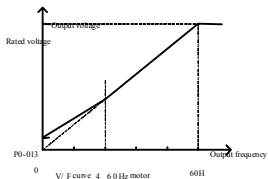
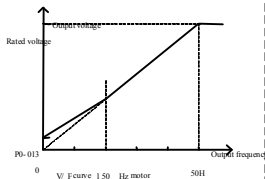

Chart 5-2 V/F curve

Detailed Function Description

P0-013	Torque boost	Setting range: 0.0~15.0 %	Factory value: 3.0 %
--------	-----------------	------------------------------	-------------------------

Set 0Hz corresponding output voltage. 1.0% significance of the function code for 1.0% inverter rated voltage. For the heavy load can be a gradual increase rate of 1.0% of the value.

P0-014	Automatic torque compensation gain	Setting range: 0.0~ 250.0%	Factory value : 100.0%
--------	---------------------------------------	-------------------------------	---------------------------

Inverter will automatically adjust the output voltage to maintain motor torque constant, especially low-frequency running to make up the voltage drop of stator resistance. When the torque is not enough to increase the function code, when the motor current is too large to decrease the function code.

This function code for 0.0 mean that the automatic torque compensation is prohibited.

Detailed Function Description

P0-015	Automatic slip compensation gain	Setting range: 0.0~250.0%	Factory value : 100.0%
--------	----------------------------------	---------------------------	------------------------

The function is used to improve the motor speed by reason of load changes. When Load is stable, if the motor fluctuation of rotate speed is large, please reduce the function code.

This function code for 0.0 mean that the automatic slip compensation is prohibited.

5. 1. 3 Input terminals

P0-016	X1 terminal function	Setting range: 0~14	Factory value: 1
P0-017	X2 terminal function	Setting range: 0~14	Factory value: 2
P0-018	X3 terminal function	Setting range: 0~14	Factory value: 4
P0-019	X4 terminal function	Setting range: 0~14	Factory value: 9

0: invalid. Idle input terminals.

1: Forward run. Forward run command input.

2: Reverse run. Reverse run command input.

- 3: 3-wire control. 3-wire system to run auxiliary input commands.
- 4: Fault reset. Fault reset command input, equal to the "reset button."
- 5: UP command. Increasing frequency command input.
- 6: DOWN command. Reduce the frequency command input.
- 7: Forward jog. Forward jog command input.
- 8: Reverse jog. Reverse Jog command input.
- 9: Coast to stop. Receives the instruction, the inverter stop output immediately, motor coast to stop.
- 10: external fault input. Used as external mechanical fault signal of inverter.
- 11: Acc/Dec speed Pause. Acc/Dec speed pause, the output frequency remain unchanged.
- 12: Muti-step speed terminal 1.
- 13: Muti-step speed terminal 2.
- 14: Frequency Source switch. When it is invalid, use "main frequency source X"; when it is effective, use "assistant

frequency source Y” .

P0-020	Control mode of terminal	Setting range: 0~3	Factory value: 0
--------	--------------------------	--------------------	------------------

0: 2-wire mode 1; 1: 2-wire mode 2.

2: 3-wire mode 1; 3: 3-wire mode 2.

2-wire run mode only need to connect two signals: Forward run and reverse run.

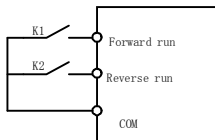

2-wire mode 1

K1	K2	Run command
OFF	OFF	stop
ON	OFF	Forward
OFF	ON	Reverse
ON	ON	stop

2-wire mode 2

K1	K2	Run command
OFF	OFF	Stop
ON	OFF	Forwaed
OFF	ON	Stop
ON	ON	Reverse

Chart 5-3 Diagram of two-wire run mode

3-wire run mode need to connect three signals: Forward run, reverse run, 3-wire run assistant.

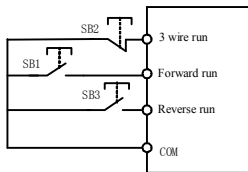

SB1 : Run
 SB2 : stop
 SB3 : Switching for direction
 3 wire mode 1

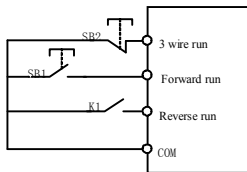

SB1 : run
 SB2 : stop
 K1 : Running direction(OFF:forward; ON:reverse)
 3 wire mode 2

Chart 5-4 Diagram of 3-wire run mode

P0-021	AIN min input	Setting range : 0.00~10.00V	Factory value: 0.00V
P0-022	AIN min input corresponding frequency	Setting range : 0.00~600.00Hz	Factory value: 0.00Hz
P0-023	AIN max input	Setting range : 0.00~10.00V	Factory value: 10.00V
P0-024	AIN max input corresponding frequency	Setting range : 0.00~600.00Hz	Factory value: 50.00Hz

When running frequency is controlled by input voltage(AIN1 or AIN2) or current, input curves (AIN1 and AIN2) are set by the

parameter of the group. Input curve diagram, such as chart 5-5.

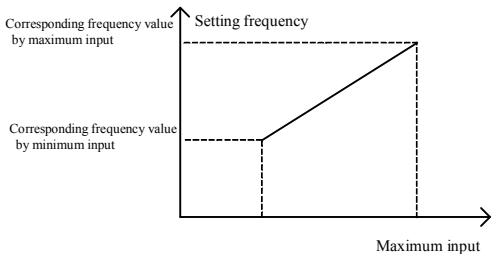

Chart 5-5 Analog input corresponding frequency

5. 1. 4 Output terminals

P0-025	Relay output selection	Setting range: 0~6	Factory value: 1
P0-026	Y1 output selection	Setting range: 0~6	Factory value: 3

0: No output. Output terminal is idle.

1: Stop fault occurred in running. the effective signal will be output

when stop fault.

2: inverter running. the effective signal will be output when running.

3: Run frequency reaches the setting value. See P0-110 Function Code Description.

4: Upper limit frequency running. When run frequency reaches Upper limit, output is an effective signal.

5: Lower limit frequency running. When run frequency reaches lower frequency, output is an effective signal.

6: Inverter zero speed running. When run frequency reaches 0Hz, output is an effective signal.

P0-027	AO1 output selection	Setting range: 0~3	Factory value: 0
--------	----------------------	--------------------	------------------

Set the physical meaning of analog output. The maximum output range is 10V.

0: Output frequency. Output frequency is 50.00Hz corresponds to 10V output.

1: output current. Output current for rated current of inverter

corresponds to 10V output.

2: output voltage. The output voltage is 500.0V corresponds to 10V output.

3: Setting frequency. Setting frequency is 50.00Hz corresponds to 10V output.

P0-028	AO1 output gain	Setting range: 0.10~10.00	Factory value: 1.00
--------	-----------------	---------------------------	---------------------

Set analog output gain.

The following diagram for the analog function of AO1 as "output frequency" , show the output gain setting.

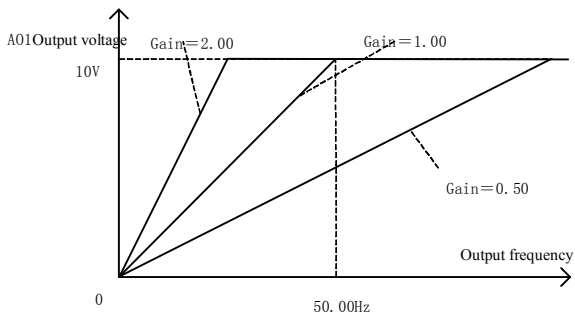

Chart 5-6 Analog Output Gain diagram

5.1.5 Keyboard setting

P0-029	DIR/JOG function selection	Setting range: 0~2	Factory value:0
--------	----------------------------	-----------------------	-----------------

0: switching at running direction.

1: jog command. The key is a jog command.

2: The key is invalid.

Detailed Function Description

P0-030	Keyboard STOP key function setting	Setting range: 0~1	Factory value: 0
--------	------------------------------------	--------------------	------------------

0: It is invalid in the analog terminal / serial communication control mode.

1: It is effective in the analog terminal / serial communication control mode (equivalent to the external fault input).

5. 1. 6 Start and Stop Control

P0-031	Stop mode	Setting range: 0~1	Factory value: 0
--------	-----------	--------------------	------------------

0: Deceleration to stop. When the stop command takes effect, the inverter decreases the output frequency, according to the selected Acc/Dec time till stop.

1: Coast to stop. When the stop command takes effect, the inverter stops the output immediately. The motor coasts to stop by its mechanical inertia.

Detailed Function Description

P0-032	Starting frequency of DC braking	Setting range: 0.00~50.00Hz	Factory value : 0.00Hz
P0-033	DC braking current	Setting range : 0.0~150.0%	Factory value: 0.0%
P0-034	DC braking time	Setting range : 0.0~60.00s	Factory value : 0.00s

The inverter decelerates to stop, when output frequency decelerates to starting frequency of DC braking, then DC braking will be started. DC braking current and DC braking time can be set separately.

5.1.7 Protect function

P0-035	Protection current of motor overload	Setting range: 50.0%~110.0%	Factory value:100.0%
--------	--------------------------------------	-----------------------------	----------------------

Overload protection is based on the motor rated current as the benchmark. When this function code is set to 50.0%, it means that the motor rated current is 50% of the inverter rated current.

Overload ability: when running at 150% motor rated current, after one minute of overload will occur, using inverse-time limit curve control.

Detailed Function Description

P0-036	Over-current protection value when lose speed	Setting range: 110.0%~200.0%	Factory value : 150.0%
--------	--	---------------------------------	---------------------------

This 100.0% of function code corresponding to rated current of inverter.

Surge current phenomenon of inverter will occur in the accelerating running process , due to acceleration time and motor inertia does not match or load inertia alters suddenly . By checking the inverter output current, and with this setting value of function code to compare, when the actual current exceeds the value, the Acc speed will be suspended until the current is reduced to less than the 5.0% of setting value.

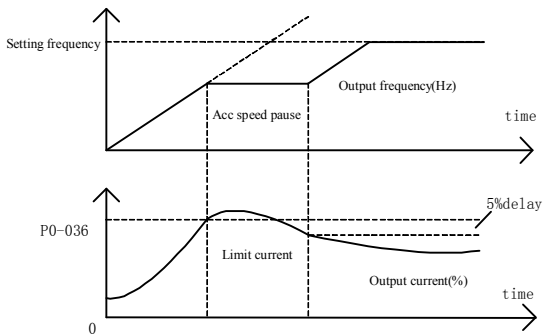

Chart 5-7 Diagram of over-current protection when lose speed

P0-037	Over-voltage protection value when lose speed	Setting range: 120.0%~150.0%	Factory value:130.0%
--------	---	---------------------------------	----------------------

This 100.0% of function code corresponding to the bus voltage 311 volts.

The surge phenomenon of inverter bus voltage will occur in the deceleration running process, due to deceleration time is set too

Detailed Function Description

short, does not match with the motor inertia. By detecting the bus voltage of inverter, and with the setting value of this function code to compare, when the actual bus voltage exceeds this value, the inverter will pause slow down until the bus voltage is reduced to less than the 5.0% of setting value , and then continue to slow down.

P0-038	Dynamic braking voltage value	Setting range:110.0 % %~140.0%	Factory value:125.0%
--------	----------------------------------	-----------------------------------	-------------------------

Set brake threshold voltage value, 100.0% corresponding for the bus voltage 311 volts.

Dynamic braking means that inverter through connecting the built-in braking resistor or external braking resistor in order to expend the bus power of inverter, this method is effective to avoid the fault of bus over-voltage.

P0-039	Auto reset times	Setting range:0~3times	Factory value:0time
--------	------------------	------------------------	---------------------

When inverter went wrong, after delaying 0.5s, will auto clean fault according to auto reset times of fault, and send run command to inverter.

When P0-039 is set to be 0, it means “auto reset” is invalid, and the fault times will be cleared.

Notice: After normal running for 60s, the fault times occurred in the past will be cleared.

P0-040	Restart after power off instantaneous	Setting range: 0~ 1	Factory value: 0
--------	--	------------------------	------------------

0: invalid.

1: effective. When running the bus voltage is too low result in under-voltage fault occurs, the inverter will automatically reset the fault, and then run automatically.

5. 1. 8 Multi-step speed

P0-041	Muti-step speed 0	Setting range : 0.00 ~ 600.00Hz	Factory value : 0.00Hz
P0-042	Muti-step speed	Setting range : 0.00 ~	Factory value :

Detailed Function Description

	1	600.00Hz	0.00Hz
P0-043	Muti-step speed 2	Setting range : 0.00 ~ 600.00Hz	Factory value : 0.00Hz
P0-044	Muti-step speed 3	Setting range : 0.00 ~ 600.00Hz	Factory value : 0.00Hz

With the use of multi-step speed terminals:

Muti-step speed terminal1	Muti-step speed terminal 2	Corresponding speed step
OFF	OFF	Muti-step speed 0
OFF	ON	Muti-step speed 1
ON	OFF	Muti-step speed 2
ON	ON	Muti-step speed 3

Chart 5-8 Diagram of multi-step mode

5. 1. 9 PID Control

P0-045	setting channels selection	Setting range: 0~6	Factory value: 0
--------	----------------------------	--------------------	------------------

0: keyboard digital setting. The PID setting is set by “P0-046” .

1: Keyboard potentiometers. The PID setting is set by keyboard

potentiometer. Setting range is 0 ~ 10.00V.

2: AIN1 (0 ~ 10V). The PID setting is set by the AIN1 voltage of control terminal.

3: AIN1 (4 ~ 20mA). The PID setting is set by the AIN1 current of control terminal. When input is a current signal, auto conversion for voltage, 4mA corresponding 0V , 20mA corresponding 10V.

4: AIN2 (0 ~ 10V). The PID setting is set by the AIN2 voltage of control terminal.

5: AIN2 (4 ~ 20mA). The PID setting is set by the AIN2 current of control terminal. Input current is automatically converted into voltage, 4mA corresponds to 0V , 20mA corresponds to 10V.

6: serial communication settings. See the description of serial communication protocol.

P0-046	PID Keyboard digital setting	Setting range: 0.00~10.00V	Factory value: 3.00V
--------	------------------------------	----------------------------	----------------------

Set the PID number setting value.

Detailed Function Description

P0-047	PID feedback channel selection	Setting range : 0~4	Factory value: 0
--------	--------------------------------	------------------------	---------------------

0: AIN1 (0 ~ 10V). The PID feedback is set by the AIN1 voltage of control terminal .

1: AIN1 (4~20mA) . The PID feedback is set by the AIN1 current of control terminal. Input current is automatically converted into voltage, 4mA corresponds to 0V , 20mA corresponds to 10V.

2: AIN2 (0 ~ 10V). The PID feedback is set by the AIN2 voltage of control terminal .

3: AIN2 (4~20mA) . The PID feedback is set by the AIN2 current of control terminal. Input current is automatically converted into voltage, 4mA corresponds to 0V , 20mA corresponds to 10V.

4: Keyboard potentiometer (use when testing).

P0-048	Proportional gain P	Setting range:0.00~10.00	Factory value:1.00
P0-049	Integral time I	Setting range:0.00~100.00s	Factory value:2.00s
P0-050	Differential time D	Setting range:0.00~100.00s	Factory value:0.00s

The proportion, integral, differential in PID regulator is

independent of each other, through their respective codes to adjust the function.

The proportional gain P: the value is bigger means that the proportion regulation is stronger. This function code is 1.00 means when the deviation of PID setting and feedback is 10.00V , the output frequency command of PID regulator is 10.00Hz (ignore the role of integral and differential).

Notice: when the function code is 0, means that the proportional regulation is prohibited.

Integral time I: the value is smaller means that the integral adjustment is stronger. This function code is 1.00s means when the deviation of PID setting and feedback is 10.00V , the output frequency command of PID regulator is 10.00Hz (ignore the role of proportion and differential).

Notice: when the function code is 0, means that the integral regulation is prohibited.

Differential time D: the value is larger means that the differential

adjustment is stronger. This function code is 1.00s means when the change rate of deviation of PID setting and feedback is 10.00V within 1s, the output frequency command of PID regulator is 10.00Hz (ignore the role of proportion and integral).

Notice: when the function code is 0, means that the differential regulation is prohibited.

5. 1. 10 Traverse frequency setting

P0-051	Traverse amplitude	Setting range:0.0~100.0% (relative to setting frequency)	Factory value : 0.0%
P0-052	Jitter frequency	Setting range:0.0~50.0% (relative to traverse amplitude)	Factory value: 0.0%
P0-053	Rise time of traverse	Setting range: 0.1~3200.0s	Factory value : 15.0s
P0-054	Fall time of traverse	Setting range: 0.1~3200.0s	Factory value : 15.0s

Traverse frequency function applies to textile and chemical fiber industries. When traverse frequency running, the output frequency of inverter will traverse up and down according to setting frequency as the center.

when the traverse amplitude is set to 0, the traverse run is invalid.

Notice: When the traverse amplitude set is too large, result in output frequency during traverse running will be higher than Upper limit, traverse running will be automatically invalid.

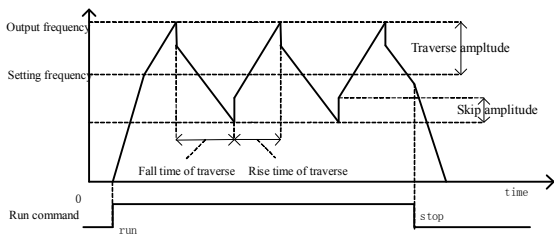

Chart 5-9 Traverse frequency run diagram

5. 1. 11 Serial Communication Settings

P0-055	Local address	Setting range: 1~32	Factory value: 1
--------	---------------	---------------------	------------------

During serial communication, the identification address of inverter.

1~31: address of slave inverter.

32: address of master inverter (be used by many inverters at the same time).

Detailed Function Description

P0-056	Baud rate	Setting range:0~4	Factory value:2
--------	-----------	-------------------	-----------------

Select data speed when serial communication.

0:2400bps; 1:4800bps; 2:9600bps; 3:19200bps; 4:38400bps.

P0-057	Data format	Setting range: 0~2	Factory value: 0
--------	-------------	--------------------	------------------

0: 1 start bit,8 data bits,no parity check, 1 stop bit.

1: 1 start bit, 8 data bits, even parity check, 1 stop bit

2: 1 start bit, 8 data bits, odd parity check, 1 stop bit.

5. 1. 12 Built-in PLC Run Mode

P0-058	PLC run mode	Setting range: 0~2	Factory value: 0
--------	--------------	--------------------	------------------

0: single-cycle. PLC cycle only once, stop after the Muti-step speed 15 has been finished .

1: continuous cycle. PLC in cycles, after the Muti-step speed 15 has been finished , a new cycle will start from Muti-step speed 0.

2: running at Muti-step speed 15 after single-cycle .after the Muti-step speed 15 has been finished . running at Muti-step speed

15 at all times.

P0-059	PLC step speed 0	Setting range:0.00 ~600.00Hz	Factory value:0.00
P0-060	PLC step speed 1	Setting range:0.00 ~600.00Hz	Factory value:1.00
P0-061	PLC step speed 2	Setting range:0.00 ~600.00Hz	Factory value:2.00
P0-062	PLC step speed 3	Setting range:0.00 ~600.00Hz	Factory value:3.00
P0-063	PLC step speed 4	Setting range:0.00 ~600.00Hz	Factory value:4.00
P0-064	PLC step speed 5	Setting range:0.00 ~600.00Hz	Factory value:5.00
P0-065	PLC step speed 6	Setting range:0.00 ~600.00Hz	Factory value:6.00
P0-066	PLC step speed 7	Setting range:0.00 ~600.00Hz	Factory value:7.00
P0-067	PLC step speed 8	Setting range:0.00 ~600.00Hz	Factory value:8.00
P0-068	PLC step speed 9	Setting range:0.00 ~600.00Hz	Factory value:9.00
P0-069	PLC step speed 10	Setting range:0.00 ~600.00Hz	Factory value:10.00
P0-070	PLC step speed 11	Setting range:0.00 ~600.00Hz	Factory value:11.00
P0-071	PLC step speed 12	Setting range:0.00 ~600.00Hz	Factory value:12.00

Detailed Function Description

P0-072	PLC step speed 13	Setting range:0.00 ~600.00Hz	Factory value:13.00
P0-073	PLC step speed 14	Setting range:0.00 ~600.00Hz	Factory value:14.00
P0-074	PLC step speed 15	Setting range:0.00 ~600.00Hz	Factory value:15.00

Set the frequency of PLC step speed 16

P0-075	Unit setting of PLC run times	Setting range:0~1	Factory value:0
--------	-------------------------------	-------------------	-----------------

0: second. The unit of PLC running time for second, set units (P0-076 ~ P0-091).

1: hour. The unit of PLC running time for hour, set units (P0-076 ~ P0-091).

P0-076	0 th -step running time	Setting range:0.0 ~ 6553.5s (h)	Factory value:0.0s
P0-077	1 th -step running time	Setting range:0.0 ~ 6553.5s (h)	Factory value:0.0s
P0-078	2 th -step running time	Setting range:0.0 ~ 6553.5s (h)	Factory value:0.0s
P0-079	3 th -step running time	Setting range:0.0 ~ 6553.5s (h)	Factory value:0.0s
P0-080	4 th -step running	Setting range:0.0~	Factory

Detailed Function Description

	time	6553.5s (h)	value:0.0s
P0-081	5 th -step running time	Setting range:0.0~6553.5s (h)	Factory value:0.0s
P0-082	6 th -step running time	Setting range:0.0~6553.5s (h)	Factory value:0.0s
P0-083	7 th -step running time	Setting range:0.0~6553.5s (h)	Factory value:0.0s
P0-084	8 th -step running time	Setting range:0.0~6553.5s (h)	Factory value:0.0s
P0-085	9 th -step running time	Setting range:0.0~6553.5s (h)	Factory value:0.0s
P0-086	10 th -step running time	Setting range:0.0~6553.5s (h)	Factory value:0.0s
P0-087	11 th -step running time	Setting range:0.0~6553.5s (h)	Factory value:0.0s
P0-088	12 th -step running time	Setting range:0.0~6553.5s (h)	Factory value:0.0s
P0-089	13 th -step running time	Setting range:0.0~6553.5s (h)	Factory value:0.0s
P0-090	14 th -step running time	Setting range:0.0~6553.5s (h)	Factory value:0.0s
P0-091	15 th -step running time	Setting range:0.0~6553.5s (h)	Factory value:0.0s

Set running time of PLC per step.

P0-092	PLC Acc/Dec setting1	time	Setting range:0~65535	Factory value:0
P0-093	PLC Acc/Dec	time	Setting range:0~	Factory

Detailed Function Description

setting2	65535	value:0
----------	-------	---------

Set acceleration and deceleration time of PLC per step, need binary switching. binary number of 16-bit, the lowest bit for the BIT0, the highest for the BIT15.

Fncion code	Binary bit	PLCstep number	Acc/Dec time 0	Acc/Dec time 1	Acc/Dec time 2	Acc/Dec time 3
P0-092	BIT1 BIT0	0	00	01	10	11
P0-092	BIT3 BIT2	1	00	01	10	11
P0-092	BIT5 BIT4	2	00	01	10	11
P0-092	BIT7 BIT6	3	00	01	10	11
P0-092	BIT9 BIT8	4	00	01	10	11
P0-092	BIT11 BIT10	5	00	01	10	11
P0-092	BIT13 BIT12	6	00	01	10	11
P0-092	BIT15 BIT14	7	00	01	10	11
P0-093	BIT1 BIT0	8	00	01	10	11
P0-093	BIT3 BIT2	9	00	01	10	11
P0-093	BIT5 BIT4	10	00	01	10	11

Detailed Function Description

Function code	Binary bit	PLCstep number	Acc/Dec time 0	Acc/Dec time 1	Acc/Dec time 2	Acc/Dec time 3
P0-093	BIT7 BIT6	11	00	01	10	11
P0-093	BIT9 BIT8	12	00	01	10	11
P0-093	BIT11 BIT10	13	00	01	10	11
P0-093	BIT13 BIT12	14	00	01	10	11
P0-093	BIT15 BIT14	15	00	01	10	11

Chart 5-10 PLC Acc/Dec time selection

To select a group of Acc/Dec time by 2 binary bits, a total of four groups can be selected. Convert the 16-bit binary number to decimal number and set to the function code.

For example: the Acc/Dec time of “PLC step speed1” and “PLC step speed15” select for “PLC Acc/Dec time 1”, other step speed Acc/Dec time select for “PLC Acc/Dec time 0”. So P0-092 is set for “4”; P0-093 is set for “16384”.

P0-094	PLC Acc time 0	Setting range:0.1~3200.0s	Factory value:15.0s
--------	----------------	---------------------------	---------------------

Detailed Function Description

P0-095	PLC Dec time0	Setting range:0.1~3200.0s	Factory value:15.0s
P0-096	PLC Acc time 1	Setting range:0.1~3200.0s	Factory value:15.0s
P0-097	PLC Dec time 1	Setting range:0.1~3200.0s	Factory value:15.0s
P0-098	PLC Acc time 2	Setting range:0.1~3200.0s	Factory value:15.0s
P0-099	PLC Dec time 2	Setting range:0.1~3200.0s	Factory value:15.0s
P0-100	PLC Acc time 3	Setting range:0.1~3200.0s	Factory value:15.0s
P0-101	PLC Dec time 3	Setting range:0.1~3200.0s	Factory value:15.0s

Set per step PLC Acc/Dec time.

P0-102	PLC run direction setting	Setting range:0~65535	Factory value:0
--------	---------------------------	-----------------------	-----------------

Set the PLC running directions , need binary switching. A binary number of 16-bit, the lowest is the BIT0, the highest is the BIT15.

BIT0 means that PLC 0th-step running direction. When BIT0=0, the 0th-step running direction is positive; when BIT0=1, the 0th-step running direction is opposite.

.....

BIT15 means that PLC 15th-step running direction. When BIT15=0, the 15th-step running direction is positive;; when BIT15=1, the 15th-step running direction is opposite.

Convert the 16-bit binary number to decimal number and set to the function code.

5.2 P1 Function Groups (Function Codes modify Setting)

P1-000	Function code writing protection	Setting range:0~1	Factory value:0
--------	----------------------------------	-------------------	-----------------

0: Invalid. P0 function group can modify.

1: effective. P0 function group can not modify.

P1-001	Function code initialization	Setting range:0~65535	Factory value:0
--------	------------------------------	-----------------------	-----------------

0: No action.

1: Initialization for the factory default values. P0 function groups renews to factory state.

5.3 P2 Function Groups (reserved)

The function groups are strictly prohibited to modify.

5.4 d0 function groups (read only)

d function groups are divided into four parts (d0, d1, d2, d3), display the historical fault information、inverter information、running status of inverter、the user interface status respectively, please look over "Function Code List."

6 Fault and trouble shooting

6.1 Fault and Alarm

Fault and alarm are abnormal working status of inverter. But both have obvious distinguish.

Inverter in running for self-monitoring. If fault issued, fault code of inverter will be displayed, and the inverter output will be shut down, result in the motor in a free-running state until stopping; If alarm issued, alarm code of inverter will be displayed, the inverter output will be not shut down, and the motor still is controlled by the inverter.

6.1.1 Fault Indication and Fault Reset

E001~E015 for fault indications.

Fault reset of inverter has many ways: operate the "reset key" of keyboard, terminal reset function, or, if necessary, shut off the main power supply for some time can make fault reset. If the

fault has disappeared, inverter will resume normal operation; if the fault still exists, inverter will be tripped again.

Notice: If the jump-start command is effective, fault reset will jump-start transmission equipment.

6. 1. 2 Alarm Indication and Alarm Reset

E030 for alarm indication.

The inverter can realize alarm reset only by “ESC key”of operation keyboard.

6. 2 Fault and Trouble Shooting

Code	Model	Reason	Solution
E001	Over-current fault	Acc/Dec time is too short. Inverter power is too small. Voltage is too low.	Increase Acc/Dec time. Select bigger capacity inverter. Inspect input voltage.
E002	Power module fault	Acc/Dec time is too short. Short-circuit on output side of inverter.	Increase Acc/Dec time. Inspect motor insulation. Ask for support.

Fault and trouble shooting

Code	Model	Reason	Solution
		Power module damaged. Exterior disturbances.	Inspect external equipment if has strong interference source.
E003	DC bus over-voltage fault	Dec time is too short and regenerative energy from the motor is too large. Network voltage is too high. Load is too heavy and regenerative energy is too large.	Extend the Dec time. Inspect input voltage. Select bigger capacity inverter.
E004	DC bus under-voltage fault	Network voltage is too low.	Inspect input voltage.
E005	Motor over-load fault	Network voltage is too low. Load is too heavy. Motor rated current setting is Incorrect. Inverter power is too small.	Inspect input voltage. Check the load, adjust the amount of torque to enhance. Reinstall rated current of the motor. Select bigger capacity inverter
E006	Inverter over-heat fault	Ambient temperature is too high. Inverter airiness is badness.	Install colling unit. To improve the ventilation.

Fault and trouble shooting

Code	Model	Reason	Solution
		Cooling fans of inverter stop or damaged Detection circuit of temperature damaged	Check or replace cooling fans Ask for support.
E007	Soft Startup fault	Soft startup circuit or contactor damaged	Ask for support.
E008	Reserved		
E009	Output phase fault	Current asymmetry on three-phase input side .	Check output wiring and motor insulation.
E010	External fault	Input terminals of external fault signal take effect. Keyboard “stop key” is set as an emergency stop .	Check the cause. Check the setting of keyboard“stop key”.
E011	Reserved		
E012	Current detection circuit fault	Current detection device is damaged.	Ask for support.
E013	EEPROM failure to read and write	Control board parts are damaged. External disturbances.	Ask for support. Inspect external equipment if has strong interference source.
E014	Reserved		

Fault and trouble shooting

Code	Model	Reason	Solution
E015	CPU is disturbed fault	External disturbances	Inspect external equipment if has strong interference source.
E030	Operation error alarm	This is a alarm, inverter output is not turn-off. Function code is locked Function code is prohibited to modify.	Press the "ESC key" exit alarm state. Check P1-000 function code Settings. The function code is ptohibited to modify in running.

Chart 6-1 Fault and trouble shooting

6.3 Common Faults and Solutions

Inverter may have following faults or malfunctions during operation, reference the following solutions.

6.3.1 No display after power on:

1. Inspect if the voltage of power supply and the rated voltage

of inverter is consistent with multi-meter. If the power supply has problem, inspect and solve it.

2. Check the CHARGE light.
3. If the above are normal, the fault may lie part of the switching power supply. Please ask for support.

6. 3. 2 Motor doesn't move after inverter running

1. For the motor has brake device, make sure that motor is not in a brake condition.
2. Disconnect the inverter and the motor wiring, run inverter in 50Hz, inspect if there is balanced three-phase output among U, V, W with multi-meter, notice: due to U, V, W phase between is a high-frequency pulse, please use analog voltage meter to measure(range for AC 500V). If the voltage is not balanced or no voltage, the inverter module is damaged. Please ask for support.
3. If the above are normal. Please ask for support.

7 Maintenance

7.1 Inspect the inverter periodically

On account of the change of inverter using environment , such as temperature、humidity、fog and other effects, as well as the internal components of inverter are aging and other factors that could cause a variety of faults. So , during in storage and use of inverter must be carried out daily inspections and maintain the inverter periodically.

Items check	Inspection contents	Methods
Terminals and screws	Whether all screws be tightened	tighten them with a screwdriver
Radiator disc	No dust	with a vacuum cleaner in $4\sim 6\text{kg/cm}^2$ pressure blow off
PCB	No dust	with a vacuum cleaner in $4\sim 6\text{kg/cm}^2$ pressure blow off
Cooling fan	smooth operation	Replace cooling fan

	and no vibration	
Power Components	No dust	with a vacuum cleaner in 4~6kg/cm ² pressure blow off
Electrolytic capacitors	Whether change colour 、 peculiar smell、 bubbling	Replace

Chart 7-1 Inspect the inverter periodically

7.2 Replacement of wearing parts

Fans and electrolytic capacitors are wearing parts, please make periodic replacement to ensure long term, In the less than 30 °C ambient temperature, load rate 80% or less, run rate of 12 hours / day cases, The replacement periods are as follows:

- 1.Fan: Must be replaced when using up to 3 years;
- 2.Electrolytic Capacitor: Must be replaced when using up to 5 years.

8 List of Function Parameters

× indicates that this parameter cannot be modified during running. ○ indicates that this parameter can be modified during running. Address items for the MODBUS register address.

8.1 P0 function groups (users setup function codes)

Code	Function name	Setting range	Units	Factory setting	Modify	Address
Basic Function						
P0-000	Select command source	0:Keypad 1:Terminal 2:Communication	1	0	○	000H

List of Function Parameters

Code	Function name	Setting range	Units	Factory setting	Modify	Address
P0-001	Select frequency source	0:main frequency source x 1:Auxiliary frequency source Y 2:main frequency source x+Auxiliary frequency source y 3:max(main frequency source x,Auxiliary frequency source y) 4:be confirmed by selection terminal of frequency source.	1	0	○	001H
P0-002	Main frequency source selection	0:keyboard poentionmeter 1:keyboard digital setting (UP、DOWN) 2:AIN1 3:AIN2 4:multi-step speed 5:PID 6: communication 7:interior PLC	1	0	○	002H

List of Function Parameters

Code	Function name	Setting range	Units	Factory setting	Modify	Address
P0-003	Auxiliary frequency source selection	0:keyboard poentionmeter 1:keyboard digital setting (UP、DOWN) 2:AIN1 3:AIN2 4:multi-step speed 5:PID 6: communication 7:interior PLC	1	0	○	003H
P0-004	Digital setting frequency of keyboard	0.00~600.00Hz	0.01Hz	50.00Hz	○	004H
P0-005	JOG frequency	0.00~600.00Hz	0.01Hz	5.00Hz	○	005H
P0-006	Running direction control	0:setting direction same 1:setting direction reverse 2:forbid reverse	1	0	×	006H
P0-007	Upper limit frequency	Lower limit ~ 600.00Hz	0.01Hz	50.00Hz	○	007H
P0-008	Lower limit frequency	0.00Hz ~ upper limit	0.01Hz	0.00Hz	○	008H

List of Function Parameters

Code	Function name	Setting range	Units	Factory setting	Modify	Address
P0-009	Acc time	0.1~3200.0s	0.1s	15.0s	○	009H
P0-010	Dec time	0.1~3200.0s	0.1s	15.0s	○	00AH
P0-011	Carrier frequency	1.0~10.0KHz	0.1KHz	6.0KHz	○	00BH
Vector Control parameter						
P0-012	V/F curve setting	1:50 Hz motor, the general load 2:50 Hz motor, high starting torque 3:50 Hz motor, reduced torque 4:60 Hz motor, the general load 5:60 Hz motor, high starting torque 6:60 Hz motor, reduced torque	1	1	×	00CH
P0-013	Torque boost	0.0~15.0%	0.1%	3.0%	×	00DH
P0-014	Automatic torque compensation gain	0.0~250.0%	0.1%	100.0%	○	00EH

List of Function Parameters

Code	Function name	Setting range	Units	Factory setting	Modify	Address
P0-015	Automatic slip compensation gain	0.0~250.0%	0.1%	100.0%	○	00FH
Input terminals						
P0-016	X1 terminal function	0:invalid 1:Forward 2:Reverse 3:3-wire control 4:Reset fault	1	1	×	010H
P0-017	X2 terminal function	5:UP command 6:DOWN command 7:JOG forward 8:JOG reverse 9:Coast to stop 10:External fault input	1	2	×	011H
P0-018	X3 terminal function	11:Acc/Dec speed Pause 12:Muti-step speed terminal 1 13:Muti-step speed	1	4	×	012H

List of Function Parameters

Code	Function name	Setting range	Units	Factory setting	Modify	Address
P0-019	X4 terminal function	terminal 2 14:switch command source	1	9	×	013H
P0-020	Control mode of terminal	0: 2-wire mode1 1: 2-wire mode 2 2: 3-wire mode 1 3: 3-wire mode 2	1	0	×	014H
P0-021	AIN min input	0.00~10.00V	0.01V	0.00V	○	015H
P0-022	AIN min input corresponding frequency	0.00~600.00Hz	0.01Hz	0.00Hz	○	016H
P0-023	AIN max input	0.00~10.00V	0.01V	10.00V	○	017H
P0-024	VCI max input corresponding frequency	0.00~600.00Hz	0.01Hz	50.00Hz	○	018H
Output terminals						

List of Function Parameters

Code	Function name	Setting range	Units	Factory setting	Modify	Address
P0-025	Relay output selection	0: Invalid 1: stop fault in running 2: inverter running 3: run frequency arrived setting value	1	1	×	019H
P0-026	Y1 output selection	4: Upper limit frequency running 5: Lower limit frequency running 6: Inverter running at zero speed	1	3	×	01AH
P0-027	AO1 output selection	0: Output frequency 1: Output current 2: Output voltage 3: Setting frequency	1	0	○	01BH
P0-028	AO1 output gain	0.10~10.00	0.01	1.00	○	01CH
Keyboard setting						
P0-029	DIR/JOG function selection	0: Running direction switch 1: JOG command 2: Invalid	1	0	○	01DH

List of Function Parameters

Code	Function name	Setting range	Units	Factory setting	Modify	Address
P0-030	Keyboard STOP key function setting	0:Invalid,when controlling by analog terminals /communication 1:effective,when controlling by analog terminals /communication (be equal external fault input)	1	0	○	01EH
Start and stop control						
P0-031	Stop mode	0: DEC stop 1: Coast to stop	1	0	○	01FH
P0-032	frequency of DC braking	0.00~50.00Hz	0.01Hz	0.00Hz	○	020H
P0-033	DC braking current	0.0~150.0%	0.1%	0.0%	○	021H
P0-034	DC braking time	0.0~60.00s	0.01s	0.00s	○	022H
Protect function						

List of Function Parameters

Code	Function name	Setting range	Units	Factory setting	Modify	Address
P0-035	Motor overload protection current	50.0%~110.0%	0.1%	100.0%	×	023H
P0-036	Over-current protection when lose speed	110.0%~200.0%	0.1%	150.0%	○	024H
P0-037	Over-voltage protection when lose speed	120.0%~150.0%	0.1%	130.0%	○	025H
P0-038	Dynamic braking voltag value	110.0%~140.0%	0.1%	125.0%	○	026H
P0-039	Auto reset times	0~3 次	1 次	0 次	○	027H
P0-040	Restart after power off instantaneous	0:invalid;1:effective	1	0	○	028H
Multi-stage speed						
P0-041	Muti-step speed 0	0.00~600.00Hz	0.01Hz	0.00Hz	○	029H
P0-042	Muti-step speed 1	0.00~600.00Hz	0.01Hz	0.00Hz	○	02AH

List of Function Parameters

Code	Function name	Setting range	Units	Factory setting	Modify	Address
P0-043	Muti-step speed 2	0.00~600.00Hz	0.01Hz	0.00Hz	○	02BH
P0-044	Muti-step speed 3	0.00~600.00Hz	0.01Hz	0.00Hz	○	02CH
PID control						
P0-045	PID setting channels selection	0:Keyboard digital setting 1:Keyboard poentionmeter 2:AIN1 (0~10V) 3:AIN1 (4~20mA) 4:AIN2 (0~10V) 5:AIN2 (4~20mA) 6: Communication	1	0	○	02DH
P0-046	PID Keyboard digital setting	0.00~10.00V	0.01V	3.00V	○	02EH

List of Function Parameters

Code	Function name	Setting range	Units	Factory setting	Modify	Address
P0-047	PID feedback selection	0:AIN1 (0~10V) 1:AIN1 (4~20mA) 2:AIN2 (0~10V) 3:AIN2 (4~20mA) 4:Keyboard poentionmeter (testing)	1	0	○	02FH
P0-048	Proportional gain P	0.00~10.00	0.01	1.00	○	030H
P0-049	Integral time I	0.00 (no integral) ~ 100.00s	0.01s	2.00s	○	031H
P0-050	Differential time D	0.00(no differential)0~100.00s	0.01s	0.00s	○	032H
Traverse frequency function						
P0-051	Traverse amplitude	0.0%~100.0% (relative to setting frequency)	0.1%	0.0%	○	033H
P0-052	Jitter frequency	0.0%~50.0% (Relative to the traverse amplitude)	0.1%	0.0%	○	034H
P0-053	Rise time of traverse	0.1~3200.0s	0.1s	15.0s	○	035H

List of Function Parameters

Code	Function name	Setting range	Units	Factory setting	Modify	Address
P0-054	Fall time of traverse	0.1~3200.0s	0.1s	15.0s	○	036H
Serial Communication Setting						
P0-055	Local address	1~31::slave address 32::master address(use by inverters)	1	1	○	037H
P0-056	Baud rate	0:2400bps 1:4800bps 2:9600bps 3:19200bps 4:38400bps	1	2	○	038H
P0-057	Data format	0:1 start bit, 8 data bits , no parity check, 1 stop bit. 1: 1 start bit, 8 data bits, even parity check, 1 stop bit 2: 1 start bit, 8 data bits, odd parity check, 1 stop bit	1	0	○	039H
Built-in PLC Run Mode						

List of Function Parameters

Code	Function name	Setting range	Units	Factory setting	Modify	Address
P0-058	PLC run mode	0:Stop after one cycle 1:continuous cycle 2:running according to 15 th -step after one cycle	1	0	×	03AH
P0-059	PLC step speed 0	0.00~600.00Hz	0.01Hz	0.00Hz	○	03BH
P0-060	PLC step speed 1	0.00~600.00Hz	0.01Hz	1.00Hz	○	03CH
P0-061	PLC step speed 2	0.00~600.00Hz	0.01Hz	2.00Hz	○	03DH
P0-062	PLC step speed 3	0.00~600.00Hz	0.01Hz	3.00Hz	○	03EH
P0-063	PLC step speed 4	0.00~600.00Hz	0.01Hz	4.00Hz	○	03FH
P0-064	PLC step speed 5	0.00~600.00Hz	0.01Hz	5.00Hz	○	040H
P0-065	PLC step speed 6	0.00~600.00Hz	0.01Hz	6.00Hz	○	041H
P0-066	PLC step speed 7	0.00~600.00Hz	0.01Hz	7.00Hz	○	042H
P0-067	PLC step speed 8	0.00~600.00Hz	0.01Hz	8.00Hz	○	043H
P0-068	PLC step speed 9	0.00~600.00Hz	0.01Hz	9.00Hz	○	044H
P0-069	PLC step speed 10	0.00~600.00Hz	0.01Hz	10.00Hz	○	045H
P0-070	PLC step speed 11	0.00~600.00Hz	0.01Hz	11.00Hz	○	046H
P0-071	PLC step speed 12	0.00~600.00Hz	0.01Hz	12.00Hz	○	047H
P0-072	PLC step speed 13	0.00~600.00Hz	0.01Hz	13.00Hz	○	048H
P0-073	PLC step speed 14	0.00~600.00Hz	0.01Hz	14.00Hz	○	049H
P0-074	PLC step speed 15	0.00~600.00Hz	0.01Hz	15.00Hz	○	04AH

List of Function Parameters

Code	Function name	Setting range	Units	Factory setting	Modify	Address
P0-075	Unit setting of PLC run times	0: Second 1: Hour	1	0	×	04BH
P0-076	0 th -step running time	0.0~6553.5s (h)	0.1s	0.0s	○	04CH
P0-077	1 th -step running time	0.0~6553.5s (h)	0.1s	0.0s	○	04DH
P0-078	2 th -step running time	0.0~6553.5s (h)	0.1s	0.0s	○	04EH
P0-079	3 th -step running time	0.0~6553.5s (h)	0.1s	0.0s	○	04FH
P0-080	4 th -step running time	0.0~6553.5s (h)	0.1s	0.0s	○	050H
P0-081	5 th -step running time	0.0~6553.5s (h)	0.1s	0.0s	○	051H
P0-082	6 th -step running time	0.0~6553.5s (h)	0.1s	0.0s	○	052H
P0-083	7 th -step running time	0.0~6553.5s (h)	0.1s	0.0s	○	053H
P0-084	8 th -step running time	0.0~6553.5s (h)	0.1s	0.0s	○	054H
P0-085	9 th -step running time	0.0~6553.5s (h)	0.1s	0.0s	○	055H

List of Function Parameters

Code	Function name	Setting range	Units	Factory setting	Modify	Address
P0-086	10 th -step running time	0.0~6553.5s (h)	0.1s	0.0s	○	056H
P0-087	11 th -step running time	0.0~6553.5s (h)	0.1s	0.0s	○	057H
P0-088	12 th -step running time	0.0~6553.5s (h)	0.1s	0.0s	○	058H
P0-089	13 th -step running time	0.0~6553.5s (h)	0.1s	0.0s	○	059H
P0-090	14 th -step running time	0.0~6553.5s (h)	0.1s	0.0s	○	05AH
P0-091	15 th -step running time	0.0~6553.5s (h)	0.1s	0.0s	○	05BH
P0-092	PLC Acc/Dec time setting1	0~65535 (Binary bit conversion)	1	0	○	05CH
P0-093	PLC Acc/Dec time setting2	0~65535 (Binary bit conversion)	1	0	○	05DH
P0-094	PLC Acc time 0	0.1~3200.0s	0.1s	15.0s	○	05EH
P0-095	PLC Dec time 0	0.1~3200.0s	0.1s	15.0s	○	05FH
P0-096	PLC Acc time 1	0.1~3200.0s	0.1s	15.0s	○	060H
P0-097	PLC Dec time 1	0.1~3200.0s	0.1s	15.0s	○	061H
P0-098	PLC Acc time 2	0.1~3200.0s	0.1s	15.0s	○	062H
P0-099	PLC Dec time 2	0.1~3200.0s	0.1s	15.0s	○	063H

List of Function Parameters

Code	Function name	Setting range	Units	Factory setting	Modify	Address
P0-100	PLC Acc time 3	0.1~3200.0s	0.1s	15.0s	○	064H
P0-101	PLC Dec time 3	0.1~3200.0s	0.1s	15.0s	○	065H
P0-102	PLC run direction setting	0~65535 (Binary bit conversion)	1	0	○	066H

8.2 P1 function groups(function codes modify setting)

code	function name	setting range	units	factory setting	modify
P1-000	Function code writing protection	0:invalid 1:effective	1	0	○
P1-001	Function code initialization	0: Invalid 1:factory default data	1	0	×

8.3 d0 Function Groups (fault information of history)

code	function name	range	units	address
d0-000	Current fault number	0 (no fault) ~18	1	300H

List of Function Parameters

code	function name	range	units	address
d0-001	Latest fault number	0 (no fault) ~18	1	301H
d0-002	Second latest fault number	0 (no fault) ~18	1	302H

8.4 d1 Function Groups (inverter information)

code	function name	range	units	address
d1-000	Software Version number	0~65535	1	400H
d1-001	Software checkout	0~65535	1	401H
d1-002	Machine model setting	E100S series: Reserved. E100Tseries: 0:G model 1:P model	1	402H
d1-003	Inverter rated power	0.5~1000.0KW	0.1KW	403H
d1-004	Inverter rated voltage	100.0V~1000.0V	0.1V	404H
d1-005	Inverter rated current	1.0~2000.0A	0.1A	405H

8.5 d2 function groups (Inverter running state)

code	function name	range	units	address
d2-000	Inverter running state	Bit0: run sign 0:in stopping 1: in running Bit1:Running direction 0:Forward 1:Reverse Bit2: control 0:long-distance control 1:Local keypad control Bit3:sight fault 0: No slight fault,1: No slight fault Bit4:fault 0:No fault 1:in Faulting (Binary, Bit0 for the lowest bit)	1	500H
d2-001	Setting frequency	0.00~600.00Hz	0.01Hz	501H
d2-002	Output frequency	0.00~600.00Hz	0.01Hz	502H
d2-003	Output current	0.1~2000.0A	0.1A	503H
d2-004	Output voltage	0.1~2000.0V	0.1V	504H
d2-005	DC bus voltage	100~1000V	1V	505H

List of Function Parameters

code	function name	range	units	address
d2-006	Over-load count	0.0~100.0%	0.1%	506H
d2-007	Inverter temperature	0~100℃	1℃	507H
d2-008	PID closed loop setting	0.00~10.00V	0.01V	508H
d2-009	PID closed loop feedback	0.00~10.00V	0.01V	509H
d2-010	X Setting (main frequency source)	0.00~600.00Hz	0.01Hz	50AH
d2-011	Y Setting (auxiliary frequency source)	0.00~600.00Hz	0.01Hz	50BH
d2-012	reserved			50CH
d2-013	reserved			50DH
d2-014	reserved			50EH
d2-015	reserved			50FH

8. 6 d3 function groups (users interface state)

code	function name	range	unit	address
------	---------------	-------	------	---------

List of Function Parameters

code	function name	range	unit	address
d3-000	Input terminal status	LED bit1:X1 0:invalid 1:effective LED bit2:X2 0:invalid 1:effective LED bit3:X3 0:invalid 1:effective LED bit4:X4 0:invalid 1:effective	1	600H
d3-001	Output terminal status	LED bit1:Y1 0:invalid 1:effective LEDbit2: MAMC 0:invalid 1:effective	1	601H
d3-002	AIN1 input voltage	0.00~10.00V	0.01V	602H
d3-003	AIN2 input voltage	0.00~10.00V	0.01V	603H
d3-004	AO output voltage	0.00~10.00V	0.01V	604H
d3-005	IBC reserved			605H
d3-006	ICC reserved			606H

9 MODBUS Communication Protocol

This chapter describes the MODBUS communication function.

Modbus protocol supports RTU mode

9.1 MODBUS Communication Modes

MODBUS communication is made of a master station (PLC or PC) and maximum of 31 slave stations. It communicates in 'point to point' master-slave mode. Master and slave communication (serial communication) is usually the way of slave station respond to the command after master station had communicated. Each master station only with a serial communication between slave. Therefore, each slave station address to be pre-set number, master station through the numbers with the signal communication. It will respond to the specified command sent by the master station.

Interval between each information must be kept as below:

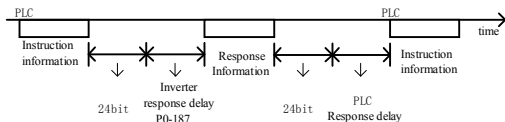

Chart 9-1 Serial Communication diagram

9.2 Information format

MODBUS communication adopts the format that master issue the directions and the slave to respond . The message formats(receive/send) are shown in chart 9-2 , according to the different content of instructions (function) , the length of the data also will be changed.

Slave address
Function code
data
Check error

Chart 9-2 Information formats of serial communication

1. Slave Address

Inverter address (0~1FHex) .If setting for 0,slave will not respond to the command sent by the master .

2. function Code

Function code is used to specify the command code. See the table below.

Function code (hex)	Function	Instruction info		Response info	
		Min (bit)	Max (bit)	Min (bit)	Max (bit)
03H	To read the contents of storage register	8	8	7	37
08H	Loopback test	8	8	8	8
10H	Multiple storage register read-in	11	41	8	8
80H	Error receiving data from slave			5	5

Chart 9-3 Serial Communication Function Code Description

3. Data

Storage register number (the test code in numbering) and its datas constitute a series of data. According to the contents of the

data length the instruction will change.

4. Check error

Using the CRC-16 (cyclic redundancy check, check sum means) to check communication errors.

The result (Check and calculate) is stored in a data(16bit) , its a start value of FFFFH.The data to be sent (slave address, function code and data), a fixed value A001H put together XOR and shift calculation. After the calculation , this data contains a checksum value.

Check and calculation according to the following methods:

- 1) The start value of 16-bit data used to calculate must be set to FFFFH.
- 2) Must be used starting value and slave address to do the XOR calculation.
- 3) The results must be shifted to the right until the overflow bit becomes 1.
- 4) When the overflow bit becomes 1, must use the

results of step 3, and a fixed value A001H to do the XOR calculation.

5) 8 times shift to calculate after (whenever the overflow bit becomes 1, must be carried out as described in Step 4 to do the XOR calculation), use the results of the previous and the next data (8-bit function code) for XOR operation. The results of this operation must again shifted eight times, when the shift in the overflow bit is 1, the need for a fixed value A001H XOR.

6) The data follow the same steps for processing. First deal with high byte, then low byte, until all data are processed.

7) The result is a check sum ,contains a high byte and low bytes.

Notice: when adding the checksum in the data frame, the first to add low byte, and then add the high bytes.

9.3 Examples of MODBUS Information

9.3.1 To read the contents of storage register

A maximum of 16 can be read out the contents of inverter memory registers every time.

First, the instruction information must contain to read out the beginning address of the first register and the amount of register. Response message will contain the contents of the register to be read. Store register content is divided into high 8 bit and low 8 bit, according to number order turn into data within a response message.

Read from the slave 2, the inverter register information 000H, 001H examples as below:

Command information		
Slave address		02H
Function code		03H
start address	High byte	00H
	Low byte	00H
Number	High byte	00H
	Low byte	02H
CRC-16	High byte	C4H
	Low byte	38H

Response information (normal)		
Slave address		02H
Function code		03H
Data code		04H
Start storage register	High byte	00H
	Low byte	00H
The next storage register	High byte	00H
	Low byte	00H
CRC-16	High byte	C9H
	Low byte	33H

Response information (fault)		
Slave address		02H
Function code		80H
Error code		02H
CRC-16	High byte	30H
	Low byte	01H

Chart 9-4 Examples of serial communication

9.3.2 Test circuit

The instruction information directly as a response message back out. To use master and slave communication testing . Test code, the data can use any value.

Carry out the slave 2 of the inverter loop test of the information shown as below:

Command information		
Slave address		02H
Function code		08H
Test code	High byte	01H
	Low byte	02H
Number	High byte	03H
	Low byte	04H
CRC-16	High byte	41H
	Low byte	37H

Response information (normal)		
Slave address		02H
Function code		08H
Test code	High byte	01H
	Low byte	02H
Number	High byte	03H
	Low byte	04H
CRC-16	High byte	41H
	Low byte	37H

Response information (fault)		
Slave address		02H
Function code		80H
Error code		03H
CRC-16	High byte	F1H
	Low byte	C1H

Chart 9-5 Examples of serial communication loop testing

9. 3. 3 Write into multi-storage register

A maximum of 16 can be written into the contents of inverter memory registers every time.

The specified data are written specified number into the specified storage register . Write into data must in accordance with the number order of register, respectively, according to a high 8 bits, low 8bits order array in the instruction information.

From PLC to the slave2 of inverter modify 000H、001H information of register,samples as below:

Command information		
Slave address		02H
Function code		10H
Start address	High byte	00H
	Low byte	00H
Number	High byte	00H
	Low byte	02H
data number		04H
Start data	High byte	00H
	Low byte	01H
The next data	High byte	00H
	Low byte	01H
CRC-16	High byte	6CH
	Low byte	EBH
Remarks:Data number=quantity*2		

Response information (normal)		
Slave address		02H
Function code		10H
Start address	High byte	00H
	Low byte	00H
Number	High byte	00H
	Low byte	02H
CRC-16	High byte	51H
	Low byte	9FH

Response information (fault)		
Slave address		02H
Function code		80H
Error code		01H
CRC-16	High byte	31H
	Low byte	C2H

Chart 9-6 write instruction samples of serial communication

9. 3. 4 Data saved instruction

After using MODBUS communication, if function code data had been written from the PLC into the inverter, it will be temporarily stored in the data field of inside converter.

Save command mean that RAM function code data is written into the internal EEPROM of inverter (permanent storage). Write 1 to the register number 0909H mean that had carried out the data storage instruction.

9. 3. 5 Broadcast model sent data

When using broadcast model sent data, an instruction can be simultaneously sent to all slaves. The slave address of instruction information must be set to 00H. All slaves have been received from the message, rather than make a response.

9.4 Inverter for slave

When the inverter address for 1 to 31, the slave converter will accept the following data.

9.4.1 Instruction Data

Instruction data as below list. only can be written by using function code10H.

MODBUS register address	Countents	
900H	Bit 0	Run instruction: 1 run; 0 stop
	Bit 1	Direction instruction: 1 reverse;0 forward
	Bit 2	JOG instruction: 1 JOG; 0 stop
	Bit 3	Reset instruction: 1 fault reset; 0 no
	Bit 4~F	reserved
901H	Frequency instruction	
902H	PID setting value	
903H~908H	reserved	
909H	Save instruction: 1 parameter data save to EEPROM	
Remarks: Bit 0 for the lowest bit		

Chart 9-7 Data definition of communication instruction

9. 4. 2 Monitoring Data

The function code of d0, d1, d2, d3 function groups can be used as surveillance data, use the 03H function Code to read the content. Each function code MODBUS register address see the function list. Transfer data to an integer, pay attention to the unit of each function code.

9. 4. 3 Set Data

The function code of P0 function group can be modified, use the 10H function code is written. MODBUS register address of all function codes see the function list. Transfer data to an integer, pay attention to the unit of each function code.

9. 4. 4 Test Data

When Looping test, receive test data of 08H function code, and respond reply.

9.5 Inverter for master

When the address of inverter is 32, the inverter will act as the master converter to send the following broadcast data. At this time the master inverter is currently running to send run and stop instructions. Setting frequency is sent as frequency instruction. MODBUS register address is 900H and 901H.

The transmission frequency of master inverter command is 50.0Hz, set the forward running information as shown below.

MODBUS register address	Contents	
900H	Bit0	Run command 1:run; 0:stop
	Bit1	Direction command 1:reverse; 0:forward
	Bit2	Reserved
	Bit 3~F	Reserved
901H	Frequency command	
Remarks: Bit0 is the lowest bit		

Command information		
Slave address	00H	
Function code	10H	
Start address	High byte	09H
	Low byte	00H
Number	High byte	00H
	Low byte	02H
data number		04H
Start data	High byte	00H
	Low byte	01H
The next data	High byte	13H
	Low byte	88H
CRC-16	High byte	C1H
	Low byte	95H

Chart 9-8 serial command samples of master inverter

9.6 MODBUS Communication Error Codes

When the slave inverter receives the data is incorrect, it will respond to function code for the data frame of 80H , see the table below:

Error codes	Contents
01H	In running, not allowed to access.
02H	Data overflow 1. MODBUS address exceed range 2. The data to write exceed the range 3. The data to write exceed the upper-lower limit range of data comments.
03H	Function code overflow

Chart 9-9 Error codes of serial communication

9.7 Back-check of no response fault for slave

In the following conditions, slaves ignore the master command information, and do not send the response information.

1. had checked up the send error in instruction

information(exceed melody、 frame、 checkout、 CRC-16).

2. It is different that slave address of instruction

information and slave address of inverter side.

3. When time intervals of data and data of composing

information exceed the length(24 bit).

Chart Index

Chart 1-1 Nameplate.....	4
Chart 1-2 Naming rule.....	5
Chart 1-3 220V series description.	5
Chart 1-4 380V series description.	6
Chart 1-5 Technology criterion....	8
Chart 2-1 Safe space.....	11
Chart 2-2 External dimension.....	12
Chart 2-3 list of External Dimension	13
Chart 2-4 installation dimension of keyboard (mm)	14
Chart 3-1 connection of periperal devices	15
Chart 3-2 standard wiring diagram	16
Chart 3-3 Description of main circuit symbol	16

Chart 3-4 Jumpers of control circuit	17
Chart 3-5 Description of control circuit terminals	19
Chart 4-1 Keypad schematic diagram	20
Chart 4-2 Key function description	21
Chart 4-3 Run state indicator light description	22
Chart 4-4 unit indicator light description	23
Chart 4-5 Description of the inverter operation status	24
chart 4-6 Fast-monitoring diagram	25
Chart 4-7 Function code setting diagram	25
Chart 4-8 Information query diagram	26
Chart 4-9 Quick debugging flowchart	27
Chart 5-1 Setting reference of carrier	

frequency	33
Chart 5-2 V/F curve.....	35
Chart 5-3 Diagram of two-wire run mode	39
Chart 5-4 Diagram of 3-wire run mode	40
Chart 5-5 Analog input corresponding frequency	41
Chart 5-6 Analog Output Gain diagram	44
Chart 5-7 Diagram of over-current protection when lose speed ...	48
Chart 5-8 Diagram of multi-step mode	51
Chart 5-9 Traverse frequency run diagram	56
Chart 5-10 PLC Acc/Dec time selection	62
Chart 6-1 Fault and trouble shooting	70
Chart 7-1 Inspect the inverter	

periodically	74
Chart 9-1 Serial Communication diagram	96
Chart 9-2 Information formats of serial communication.....	96
Chart 9-3 Serial Communication Function Code Description	97
Chart 9-4 Examples of serial communication	101
Chart 9-5 Examples of serial communication loop testing ..	101
Chart 9-6 write instruction samples of serial communication	102
Chart 9-7 Data definition of communication instruction	104
Chart 9-8 serial command samples of master inverter	106

Chart 9-9	Error codes of serial communication	107
-----------	---	-----

深圳市南方安华电子科技有限公司

SHENZHEN NOWFOREVER ELECTRONICS TECHNOLOGY CO.,LTD

In order to improve our products constantly, we remain the power of designs modified .

3/8/2010